

SOLENOID VALVES

2/2 Pilot Operated

















40

Normally closed pilot operated solenoid valve suitable for non aggressive gases and fluids.

When energized the solenoid opens the pilot hole thus reducing the pressure above the diaphragm. The pressure under the diaphragm becomes higher and lifts from the valve seat. The specified minimum pressure must always be available as pressure difference.

Technical Features

Pressure range:	0,3-20 bar (see table)
Connection:	Female thread 1/4" - 2" acc. to DIN ISO 228
Standard voltages:	24, 110, 230V/50-60Hz ±10% 12, 24, 110VDC ±10%
Temperature range:	-10...+80°C at 35°C ambient temperature
Viscosity:	Max 22 mm ² /s
Body:	Brass
Metallic internals:	Brass and stainless steel 1.4104 (AISI430F)
Diaphragm:	NBR
Installation:	Actuator in any position
Duty factor:	100% ED-VDE0580
Protection class:	IP65 acc. to DIN EN 60529 ATEX II 2G EEx m II T4 / II 2D IP65 T130°C (Valid for models marked  below)
Other:	1 1/4"-2" is equipped with variable close muting as standard

Type	G	Seat mm	Pressure range bar	Power AC	Power DC	Kv m ³ /h
4021D/1001/.182-..V/..Hz	1/4"	13,5	0,3-20	10,5/11VA	6,8W	1,6
4022D/1001/.182-..V/..Hz	3/8"	13,5	0,3-20	10,5/11VA	6,8W	3,3
4023D/1001/.182-..V/..Hz	1/2"	13,5	0,3-20	10,5/11VA	6,8W	3,8
4024D/1001/.182-..V/..Hz	3/4"	27,5	0,3-16	10,5/11VA	6,8W	11,0
4024D/1001/.032-..V/..Hz	3/4"	27,5	0,3-20	18/19VA	11W	11,0
4025D/1001/.182-..V/..Hz	1"	27,5	0,3-16	10,5/11VA	6,8W	13,0
4025D/1001/.032-..V/..Hz	1"	27,5	0,3-20	18/19VA	11W	13,0
4026B/1001/.032-..V/..Hz	1 1/4"	40,0	0,5-16	18/19VA	11W	30,0
4027B/1001/.032-..V/..Hz	1 1/2"	40,0	0,5-16	18/19VA	11W	32,0
4028B/1001/.032-..V/..Hz	2"	50,0	0,5-16	18/19VA	11W	36,0
4021/1001/.178-..V/..Hz 	1/4"	13,5	0,3-10	5,3VA	5,2W	1,6
4021/1001/.148-..V/..Hz 	1/4"	13,5	0,3-20	8,5VA	10W	1,6
4022/1001/.178-..V/..Hz 	3/8"	13,5	0,3-10	5,3VA	5,2W	3,3
4022/1001/.148-..V/..Hz 	3/8"	13,5	0,3-20	8,5VA	10W	3,3
4023/1001/.178-..V/..Hz 	1/2"	13,5	0,3-10	5,3VA	5,2W	3,8
4023/1001/.148-..V/..Hz 	1/2"	13,5	0,3-20	8,5VA	10W	3,8
4024/1001/.178-..V/..Hz 	3/4"	27,5	0,3-10	5,3VA	5,2W	11,0
4024/1001/.148-..V/..Hz 	3/4"	27,5	0,3-20	8,5VA	10W	11,0
4025/1001/.178-..V/..Hz 	1"	27,5	0,3-10	5,3VA	5,2W	13,0
4025/1001/.148-..V/..Hz 	1"	27,5	0,3-20	8,5VA	10W	13,0
4026/1001/.148-..V/..Hz 	1 1/4"	40,0	0,5-16	8,5VA	10W	30,0
4027/1001/.148-..V/..Hz 	1 1/2"	40,0	0,5-16	8,5VA	10W	32,0
4028/1001/.148-..V/..Hz 	2"	50,0	0,5-16	8,5VA	10W	36,0

NO - Valve Normally Open

4021/1001/.012-NO-..V/..Hz	1/4"	13,5	0,3-20	24VA	18,5W	1,6
4022/1001/.012-NO-..V/..Hz	3/8"	13,5	0,3-20	24VA	18,5W	3,3
4023/1001/.012-NO-..V/..Hz	1/2"	13,5	0,3-20	24VA	18,5W	3,8
4024/1001/.012-NO-..V/..Hz	3/4"	27,5	0,3-20	24VA	18,5W	11,0
4025/1001/.012-NO-..V/..Hz	1"	27,5	0,3-20	24VA	18,5W	13,0
4026/1001/.012-NO-..V/..Hz	1 1/4"	40,0	0,5-16	24VA	18,5W	30,0
4027/1001/.012-NO-..V/..Hz	1 1/2"	40,0	0,5-16	24VA	18,5W	32,0
4028/1001/.012-NO-..V/..Hz	2"	50,0	0,5-16	24VA	18,5W	36,0

SOLENOID VALVES

2/2 Pilot Operated

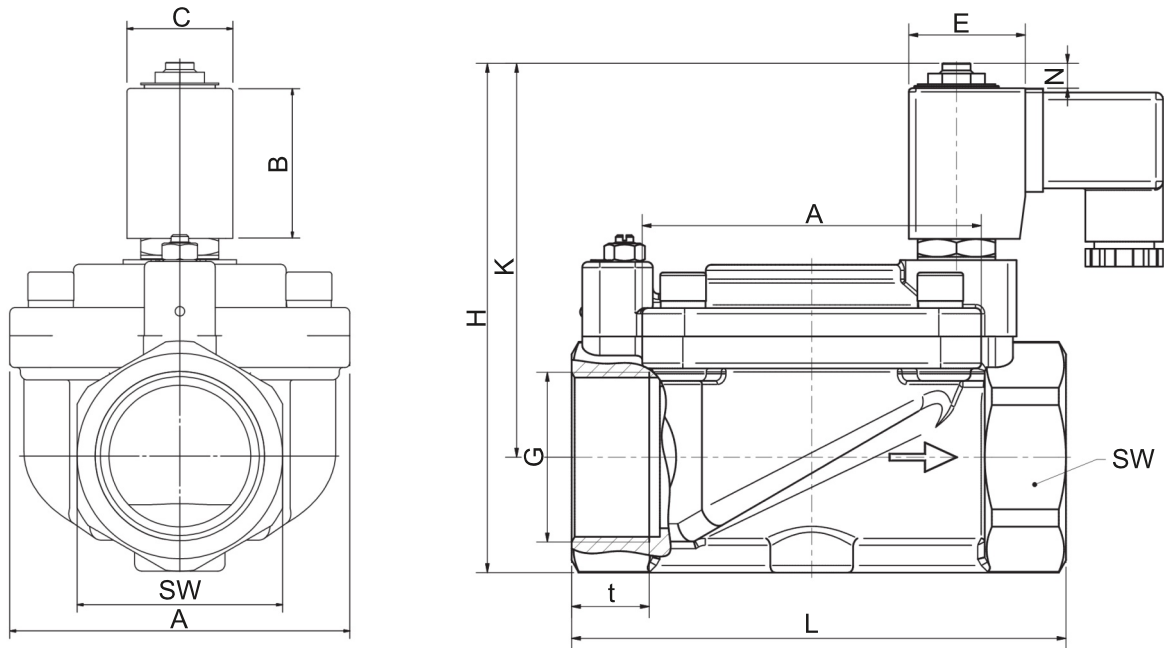

Dimensions, mm

Type	G	A	B	C	E	H	K	L	N	SW	t
4021D/1001/.182-..V/..Hz	1/4"	45	30	30	35	95	75	67	4,5	27	12
4022D/1001/.182-..V/..Hz	3/8"	45	30	30	35	95	75	67	4,5	27	12
4023D/1001/.182-..V/..Hz	1/2"	45	30	30	35	95	75	67	4,5	27	12
4024D/1001/.182-..V/..Hz	3/4"	70	30	30	35	106	82	96	4,5	41	16
4024D/1001/.032-..V/..Hz	3/4"	70	40	30	39	121	97	96	10,0	41	16
4025D/1001/.182-..V/..Hz	1"	70	30	30	35	106	82	96	4,5	41	16
4025D/1001/.032-..V/..Hz	1"	70	40	30	39	121	97	96	10,0	41	16
4026B/1001/.032-..V/..Hz	1 1/4"	96	40	30	39	143	110	140	10,0	58	22
4027B/1001/.032-..V/..Hz	1 1/2"	96	40	30	39	143	110	140	10,0	58	22
4028B/1001/.032-..V/..Hz	2"	112	40	30	39	161	121	168	10,0	70	25

Normally open, NO

4021D/1001/.012-NO-..V/..Hz	1/4"	45	40	36	45	105	90	67	10,0	27	12
4022D/1001/.012-NO-..V/..Hz	3/8"	45	40	36	45	105	90	67	10,0	27	12
4023D/1001/.012-NO-..V/..Hz	1/2"	45	40	36	45	105	90	67	10,0	27	12
4024D/1001/.012-NO-..V/..Hz	3/4"	70	40	36	45	121	97	96	10,0	41	16
4025D/1001/.012-NO-..V/..Hz	1"	70	40	36	45	121	97	96	10,0	41	16
4026B/1001/.012-NO-..V/..Hz	1 1/4"	96	40	36	45	143	110	140	10,0	58	22
4027B/1001/.012-NO-..V/..Hz	1 1/2"	96	40	36	45	143	110	140	10,0	58	22
4028B/1001/.012-NO-..V/..Hz	2"	112	40	36	45	161	121	168	10,0	70	25

Options

FKM or EPDM diaphragm

Variable close muting (3/4" och 1")

Manual operation

High temperature execution for mediatemperature up to +130°C