

SOLENOID VALVES

2/2 Force Pilot Operated



















43

Normally closed force pilot operated solenoid valve suitable for non aggressive gases and fluids. When energized the solenoid first opens the pilot hole and then lifts directly or supported by a pressure difference the diaphragm from the valve seat. The valve is closed by spring power.

Technical Features

Pressure range:	0-16 bar (see table)
Connection:	Female thread 1/4" - 2" acc. to DIN ISO 228
Standard voltages:	24, 110, 230V/50-60Hz ±10% 12, 24, 110VDC ±10%
Temperature range:	-10...+80°C at 35°C ambient temperature
Viscosity:	Max 22 mm ² /s
Body:	Brass
Metallic internals:	Brass and stainless steel 1.4104 (AISI430F)
Diaphragm:	NBR
Installation:	Actuator only in upright position
Duty factor:	100% ED-VDE0580
Protection class:	IP65 acc. to DIN EN 60529 ATEX II 2G EEx m II T4 / II 2D IP65 T130°C (Valid for models marked  below)
Other:	1 1/4"-2" is equipped with variable close muting as standard

Type	G	Seat mm	Pressure range bar	Power AC	Power DC	Kv m ³ /h
4321E/1001/.032-../..Hz	1/4"	13,5	0-10	18/19VA	11W	-
4321D/1001/.012-../..Hz	1/4"	13,5	0-12	24VA	18,5W	-
4321D/1001/.702-../..Hz	1/4"	13,5	0-16	25W	25W	1,8
4322E/1001/.032-../..Hz	3/8"	13,5	0-10	18/19VA	11W	-
4322D/1001/.012-../..Hz	3/8"	13,5	0-12	24VA	18,5W	-
4322D/1001/.702-../..Hz	3/8"	13,5	0-16	25W	25W	3,6
4323E/1001/.032-../..Hz	1/2"	13,5	0-10	18/19VA	11W	-
4323D/1001/.012-../..Hz	1/2"	13,5	0-12	24VA	18,5W	-
4323D/1001/.702-../..Hz	1/2"	13,5	0-16	25W	25W	3,9
4324E/1001/.032-../..Hz	3/4"	27,5	0-6	18/19VA	11W	-
4324D/1001/.012-../..Hz	3/4"	27,5	0-10	24VA	18,5W	-
4324D/1001/.702-../..Hz	3/4"	27,5	0-16	25W	25W	10,8
4325E/1001/.032-../..Hz	1"	27,5	0-6	18/19VA	11W	-
4325D/1001/.012-../..Hz	1"	27,5	0-10	24VA	18,5W	-
4325D/1001/.702-../..Hz	1"	27,5	0-16	25W	25W	13,0
4326B/1001/.322-../..Hz	1 1/4"	40,0	0-10	30W	30W	-
4326B/1001/.242-../..Hz	1 1/4"	40,0	0-16	46W	46W	22,0
4327B/1001/.322-../..Hz	1 1/2"	40,0	0-10	30W	30W	-
4327B/1001/.242-../..Hz	1 1/2"	40,0	0-16	46W	46W	25,0
4328B/1001/.322-../..Hz	2"	50,0	0-6	30W	30W	-
4328B/1001/.242-../..Hz	2"	50,0	0-16	46W	46W	30,0
4321/1001/.148-../..Hz 	1/4"	13,5	0-4	8,5VA	10W	-
4321/1001/.808-../..Hz 	1/4"	13,5	0-16	24W	24W	-
4322/1001/.148-../..Hz 	3/8"	13,5	0-4	8,5VA	10W	-
4322/1001/.808-../..Hz 	3/8"	13,5	0-16	24W	24W	-
4323/1001/.148-../..Hz 	1/2"	13,5	0-4	8,5VA	10W	-
4323/1001/.808-../..Hz 	1/2"	13,5	0-16	24W	24W	-
4324/1001/.148-../..Hz 	3/4"	27,5	0-4	8,5VA	10W	-
4324/1001/.808-../..Hz 	3/4"	27,5	0-16	24W	24W	-
4325/1001/.148-../..Hz 	1"	27,5	0-4	8,5VA	10W	-
4325/1001/.808-../..Hz 	1"	27,5	0-16	24W	24W	-
4326/1001/.248-../..Hz 	1 1/4"	40,0	0-10	30W	30W	-
4326/1001/.278-../..Hz 	1 1/4"	40,0	0-16	47W	47W	-
4327/1001/.248-../..Hz 	1 1/2"	40,0	0-10	30W	30W	-
4327/1001/.278-../..Hz 	1 1/2"	40,0	0-16	47W	47W	-
4328/1001/.248-../..Hz 	2"	50,0	0-6	30W	30W	-
4328/1001/.278-../..Hz 	2"	50,0	0-16	47W	47W	-

SOLENOID VALVES

2/2 Force Pilot Operated

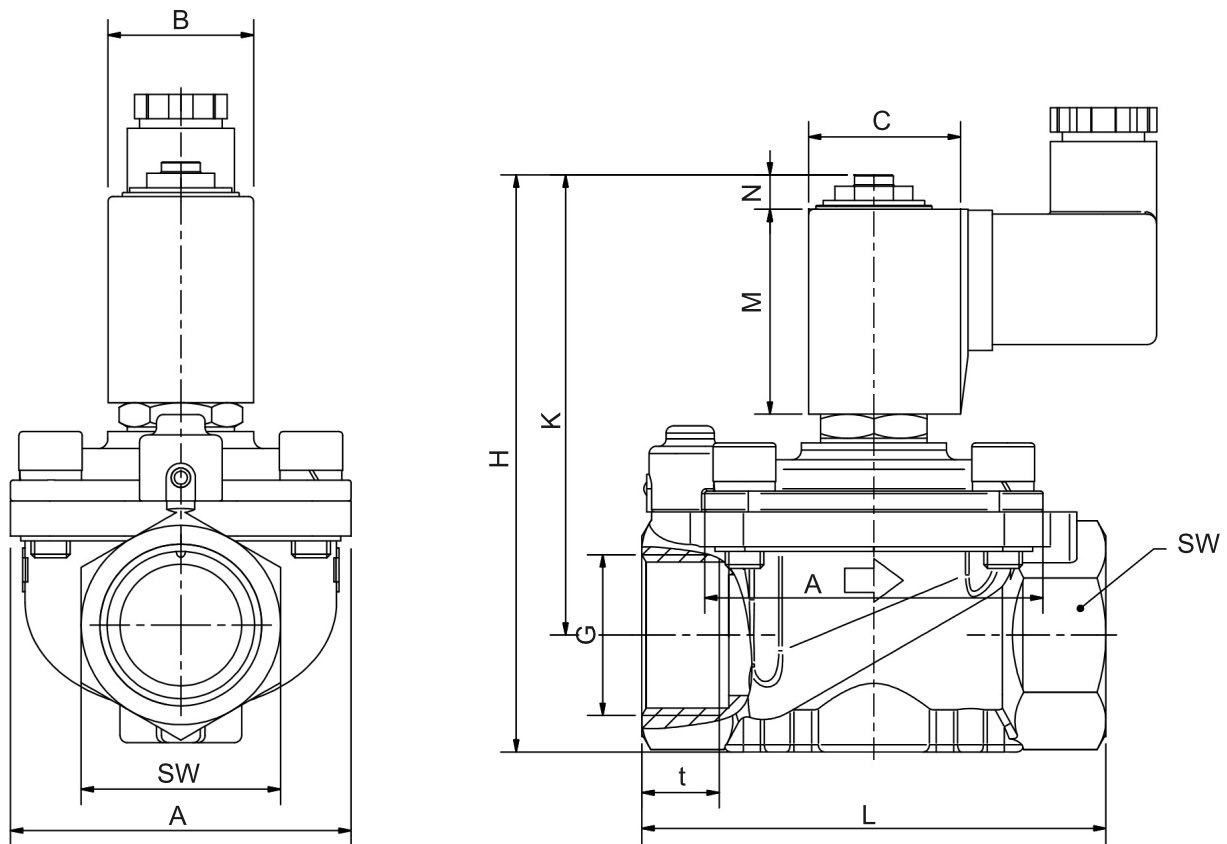

Dimensions, mm

Benämning	G	A	B	C	H	K	L	M	N	SW	t
4321E/1001/.032-..V/..Hz	1/4"	44	30	39	122	107	67	40	10	27	12
4321D/1001/.012-..V/..Hz	1/4"	44	36	45	122	107	67	40	10	27	12
4321D/1001/.702-..V/..Hz	1/4"	44	36	54	132	119	67	54	10	27	12
4322E/1001/.032-..V/..Hz	3/8"	44	30	39	122	107	67	40	10	27	12
4322D/1001/.012-..V/..Hz	3/8"	44	36	45	122	107	67	40	10	27	12
4322D/1001/.702-..V/..Hz	3/8"	44	36	54	132	119	67	54	10	27	12
4323E/1001/.032-..V/..Hz	1/2"	44	30	39	122	107	67	40	10	27	12
4323D/1001/.012-..V/..Hz	1/2"	44	36	45	122	107	67	40	10	27	12
4323D/1001/.702-..V/..Hz	1/2"	44	36	54	132	119	67	54	10	27	12
4324E/1001/.032-..V/..Hz	3/4"	70	30	39	130	117	96	40	10	41	16
4324D/1001/.012-..V/..Hz	3/4"	70	36	45	150	117	96	40	10	41	16
4324D/1001/.702-..V/..Hz	3/4"	70	36	54	130	127	96	54	10	41	16
4325E/1001/.032-..V/..Hz	1"	70	30	39	150	117	96	40	10	41	16
4325D/1001/.012-..V/..Hz	1"	70	36	45	130	117	96	40	10	41	16
4325D/1001/.702-..V/..Hz	1"	70	36	54	150	127	96	54	10	41	16
4326B/1001/.322-..V/..Hz	1 1/4"	96	Ø63	-	208	175	140	59	16	58	22
4326B/1001/.242-..V/..Hz	1 1/4"	96	Ø77	-	233	200	140	70	19	58	22
4327B/1001/.322-..V/..Hz	1 1/2"	96	Ø63	-	208	175	140	59	16	58	22
4327B/1001/.242-..V/..Hz	1 1/2"	96	Ø77	-	233	200	140	70	19	58	22
4328B/1001/.322-..V/..Hz	2"	112	Ø63	-	242	207	168	59	19	70	25
4328B/1001/.242-..V/..Hz	2"	112	Ø77	-	242	207	168	70	19	70	25

Options

FKM or EPDM diaphragm

Non energized open execution, NO

Manual operation

High temperature execution for mediatemperature up to +130°C