

## 2/2-vägs tvångsstyrd



### Serie 24







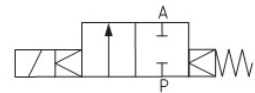

Normalt stängd tvångsstyrd magnetventil för neutrala gaser och vätskor.  
Vid spänning lyfts ankaret från pilothålet och lyfter kolven direkt eller med hjälp av mediatrycket. Ventilen stänger med fjäderkraft.

### Teknisk Specifikation

Tryckområde:	0-40 bar (se tabell)
Anslutning:	Fläns PN 10/16/25/40 EN 1092-1 Form C och DIN 3202-F1
Standardspänningar:	24, 110, 230V/50-60Hz ±10% 12, 24, 110VDC ±10%
Temperaturområde:	-30...+80°C vid 40°C omgivningstemperatur
Viskositet:	Max 22 mm <sup>2</sup> /s
Ventilhus:	Syrafast stål 1.4408 (AISI316)
Innerdelar:	Rostfritt stål 1.4104 (AISI430F)
Kolv tätning:	PTFE
Inbyggnadsläge:	Endast med stående magnetsystem
Relativ inkopplingstid:	100% ED-VDE0580
Skyddsklass:	IP65 enligt DIN 40050 ATEX II 2G EEx e mb II T4 / II 2D IP65 T130°C (Gäller ventil med  nedan)



Benämning	DN	Ø Säte mm	Tryckområde bar	Effekt W	Kv m <sup>3</sup> /h
2407/0804/.242-..V/..Hz	65	65	0-16	46	75
2407/0804/.272-..V/..Hz	65	65	0-40	100	75
2408/0804/.242-..V/..Hz	80	80	0-16	46	97
2408/0804/.272-..V/..Hz	80	80	0-25	100	97
2408/0804/.352-..V/..Hz	80	80	0-40	150	97
2409/0804/.272-..V/..Hz	100	100	0-16	100	143
2409/0804/.352-..V/..Hz	100	100	0-40	150	143
2410/0804/.272-..V/..Hz	125	125	0-16	100	240
2411/0804/.352-..V/..Hz	150	150	0-16	150	370

Benämning	DN	Ø Säte mm	Tryckområde bar	Effekt W	Kv m <sup>3</sup> /h
2407/0804/.248-..V/..Hz 	65	65	0-4	30	75
2407/0804/.278-..V/..Hz 	65	65	0-16	47	75
2408/0804/.278-..V/..Hz 	80	80	0-16	47	97
2408/0804/.358-..V/..Hz 	80	80	0-40	75	97
2409/0804/.278-..V/..Hz 	100	100	0-10	47	143
2409/0804/.358-..V/..Hz 	100	100	0-40	75	143
2410/0804/.278-..V/..Hz 	125	125	0-8	47	240
2410/0804/.358-..V/..Hz 	125	125	0-16	75	240
2411/0804/.358-..V/..Hz 	150	150	0-10	75	370

### Övriga utföranden

Handmanöver för manuell nödkörning  
Spänningslöst öppet utförande, NO  
Sätetätning av FKM eller EPDM

# MAGNETVENTILER

2/2-vägs tvångsstyrd

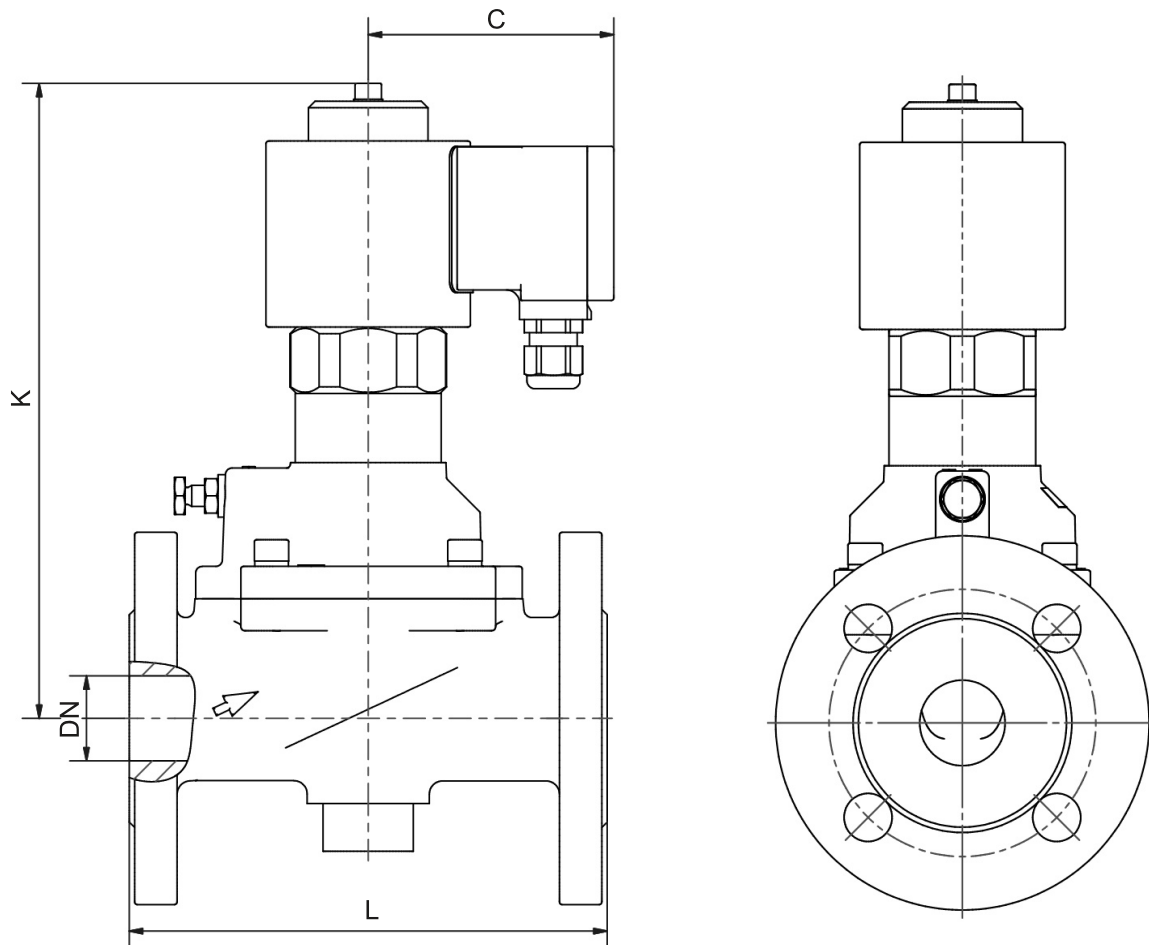

## Dimensioner

Benämning	DN	C	K	L	Kg
2407/0804/.242-..V/..Hz	65	93	270	290	35
2407/0804/.272-..V/..Hz	65	107	310	290	38
2408/0804/.242-..V/..Hz	80	93	270	310	44
2408/0804/.272-..V/..Hz	80	107	345	310	47
2408/0804/.352-..V/..Hz	80	120	480	310	39
2409/0804/.272-..V/..Hz	100	107	400	350	63
2409/0804/.352-..V/..Hz	100	120	560	350	60
2410/0804/.272-..V/..Hz	125	107	355	400	80
2411/0804/.352-..V/..Hz	150	127	600	480	95