

2/2-vägs servostyrd









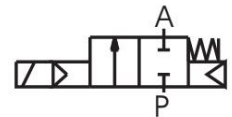

Serie 40

Normalt stängd servostyrd magnetventil för neutrala gaser och vätskor.
Vid spänning lyfts ankaret från pilothålet och avlastar trycket på ovansidan av membranet, som lyfts från sätet och öppnar ventilen. Ventilen stänger med differenstryck.

Teknisk Specifikation

Tryckområde:	0,3-20 bar (se tabell)
Anslutning:	Invändig gänga 1/4" - 2" enligt DIN ISO 228
Standardspänningar:	24, 110, 230V/50-60Hz ±10% 12, 24, 110VDC ±10%
Temperaturområde:	-10...+80°C vid 35°C omgivningstemperatur
Viskositet:	Max 22 mm ² /s
Ventilhus:	Syrafast stål 1.4581 (AISI316Ti)
Innerdelar:	Rostfritt stål 1.4104 (AISI430F)
Membran:	NBR
Inbyggnadsläge:	Valfritt
Relativ inkopplingstid:	100% ED-VDE0580
Skyddsklass:	IP65 enligt DIN EN 60529 ATEX II 2G EEx m II T4 / II 2D IP65 T130°C (Gäller ventil med  nedan)
Övrigt:	1 1/4"-2" är mjukstängande med reglerbar stängningstid



Benämning	G	Säte mm	Tryckområde bar	Effekt AC	Effekt DC	Kv m ³ /h
4021D/0801/.032-..V/..Hz	1/4"	13,5	0,3-20	18/19VA	11W	1,6
4022D/0801/.032-..V/..Hz	3/8"	13,5	0,3-20	18/19VA	11W	3,3
4023D/0801/.032-..V/..Hz	1/2"	13,5	0,3-20	18/19VA	11W	3,8
4024D/0801/.032-..V/..Hz	3/4"	27,5	0,3-20	18/19VA	11W	11,0
4025D/0801/.032-..V/..Hz	1"	27,5	0,3-20	18/19VA	11W	13,0
4026B/0801/.032-..V/..Hz	1 1/4"	40,0	0,5-16	18/19VA	11W	30,0
4027B/0801/.032-..V/..Hz	1 1/2"	40,0	0,5-16	18/19VA	11W	32,0
4028B/0801/.032-..V/..Hz	2"	50,0	0,5-16	18/19VA	11W	36,0
4021D/0801/.148-..V/..Hz 	1/4"	13,5	0,3-20	8,5VA	10W	1,6
4022D/0801/.148-..V/..Hz 	3/8"	13,5	0,3-20	8,5VA	10W	3,3
4023D/0801/.148-..V/..Hz 	1/2"	13,5	0,3-20	8,5VA	10W	3,8
4024D/0801/.148-..V/..Hz 	3/4"	27,5	0,3-20	8,5VA	10W	11,0
4025D/0801/.148-..V/..Hz 	1"	27,5	0,3-20	8,5VA	10W	13,0
4026B/0801/.148-..V/..Hz 	1 1/4"	40,0	0,5-16	8,5VA	10W	30,0
4027B/0801/.148-..V/..Hz 	1 1/2"	40,0	0,5-16	8,5VA	10W	32,0
4028B/0801/.148-..V/..Hz 	2"	50,0	0,5-16	8,5VA	10W	36,0

NO - Strömlöst öppet utförande

Benämning	G	Säte mm	Tryckområde bar	Effekt AC	Effekt DC	Kv m ³ /h
4021D/0801/.012-NO-..V/..Hz	1/4"	13,5	0,3-20	24VA	18,5W	1,6
4022D/0801/.012-NO-..V/..Hz	3/8"	13,5	0,3-20	24VA	18,5W	3,3
4023D/0801/.012-NO-..V/..Hz	1/2"	13,5	0,3-20	24VA	18,5W	3,8
4024D/0801/.012-NO-..V/..Hz	3/4"	27,5	0,3-20	24VA	18,5W	11,0
4025D/0801/.012-NO-..V/..Hz	1"	27,5	0,3-20	24VA	18,5W	13,0
4026B/0801/.012-NO-..V/..Hz	1 1/4"	40,0	0,5-16	24VA	18,5W	30,0
4027B/0801/.012-NO-..V/..Hz	1 1/2"	40,0	0,5-16	24VA	18,5W	32,0
4028B/0801/.012-NO-..V/..Hz	2"	50,0	0,5-16	24VA	18,5W	36,0

2/2-vägs servostyrd

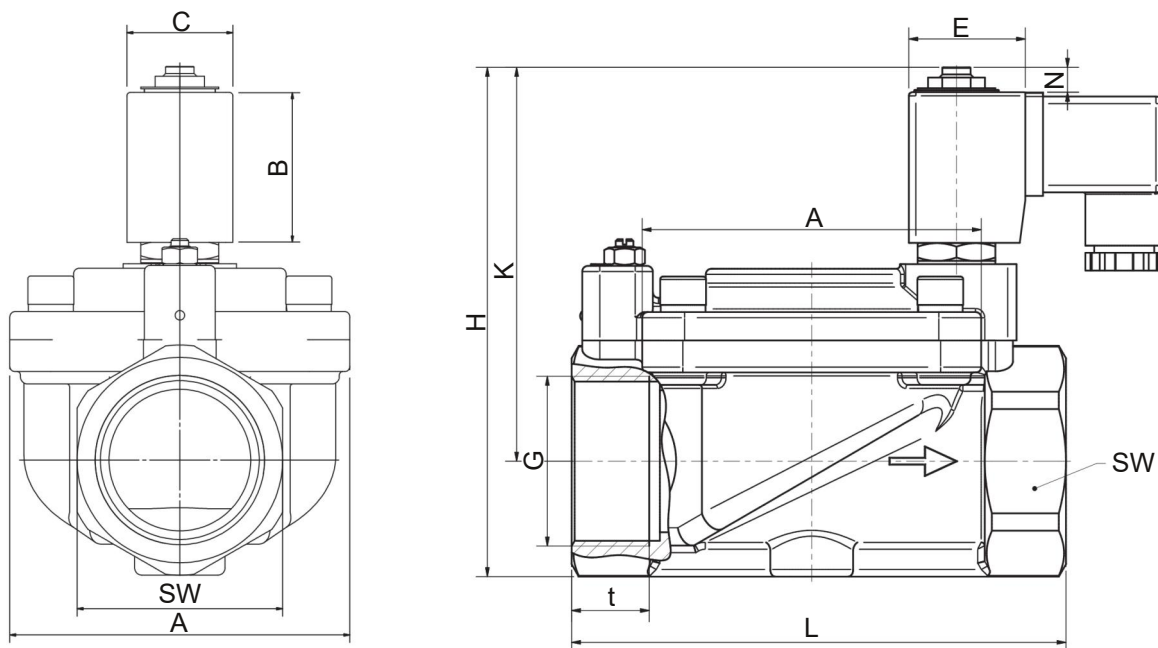

Dimensioner

Benämning	G	A	B	C	E	H	K	L	N	SW	t
4021D/0801/.032-..V/..Hz	1/4"	45	40	30	39	105	90	67	10,0	27	12
4022D/0801/.032-..V/..Hz	3/8"	45	40	30	39	105	90	67	10,0	27	12
4023D/0801/.032-..V/..Hz	1/2"	45	40	30	39	105	90	67	10,0	27	12
4024D/0801/.032-..V/..Hz	3/4"	70	40	30	39	121	97	96	10,0	41	16
4025D/0801/.032-..V/..Hz	1"	70	40	30	39	121	97	96	10,0	41	16
4026B/0801/.032-..V/..Hz	1 1/4"	96	40	30	39	143	110	140	10,0	58	22
4027B/0801/.032-..V/..Hz	1 1/2"	96	40	30	39	143	110	140	10,0	58	22
4028B/0801/.032-..V/..Hz	2"	112	40	30	39	161	121	168	10,0	70	25

Spänningslöst öppet utförande, NO

4021D/0801/.012-NO-..V/..Hz	1/4"	45	40	36	45	105	90	67	10,0	27	12
4022D/0801/.012-NO-..V/..Hz	3/8"	45	40	36	45	105	90	67	10,0	27	12
4023D/0801/.012-NO-..V/..Hz	1/2"	45	40	36	45	105	90	67	10,0	27	12
4024D/0801/.012-NO-..V/..Hz	3/4"	70	40	36	45	121	97	96	10,0	41	16
4025D/0801/.012-NO-..V/..Hz	1"	70	40	36	45	121	97	96	10,0	41	16
4026B/0801/.012-NO-..V/..Hz	1 1/4"	96	40	36	45	143	110	140	10,0	58	22
4027B/0801/.012-NO-..V/..Hz	1 1/2"	96	40	36	45	143	110	140	10,0	58	22
4028B/0801/.012-NO-..V/..Hz	2"	112	40	36	45	161	121	168	10,0	70	25

Övriga utföranden

Membran av FKM eller EPDM

Reglerbar stängningstid (3/4" och 1")

Handmanöver för manuell öppning och stängning av ventil

Högtemperaturutförande för mediatemperatur upp till +130°C